



CITROEN BERLINGO III XL(L2)
 PEUGEOT PARTNER III(L2), Rifter XL(L2)
 OPEL COMBO III XL(L2)

06/2018 -

Cat. No. **C/045**

E20

E20*55R01/07*005804*00

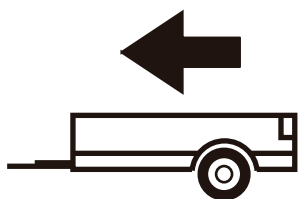

1600kg

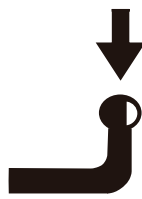

75kg

D = 9,43kN

D (kN) =



MAX kg

x

MAX kg

x 0,00981



MAX kg

+

MAX kg



IMIOLA HAK-POL

96-111 KOWIESY, CHOJNATA 23A, POLAND

Tel. + 48 46 831 73 31, fax +48 831 74 29

e-mail: office@imiola.pl, www.imiola.pl

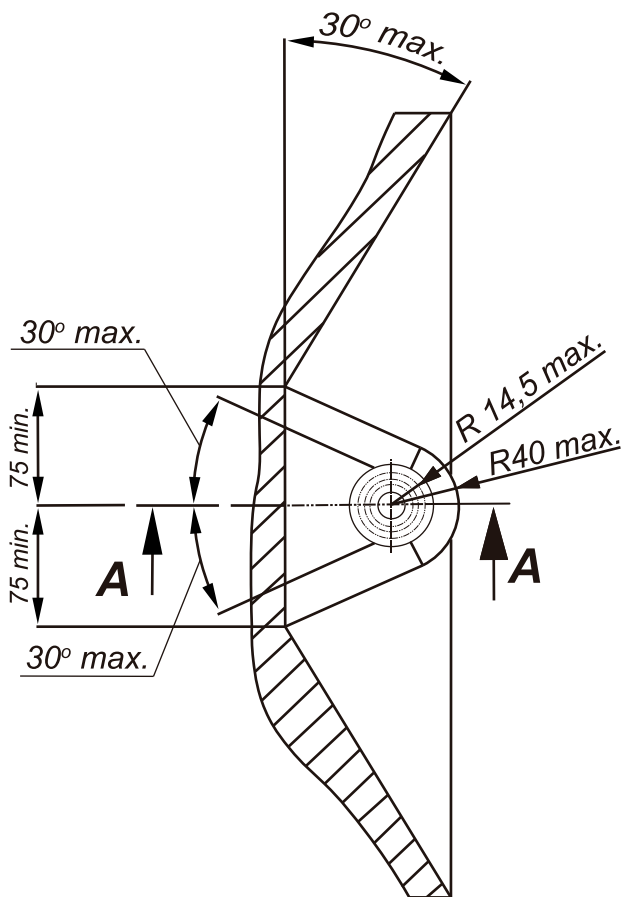

PRZEKRÓJ A-A

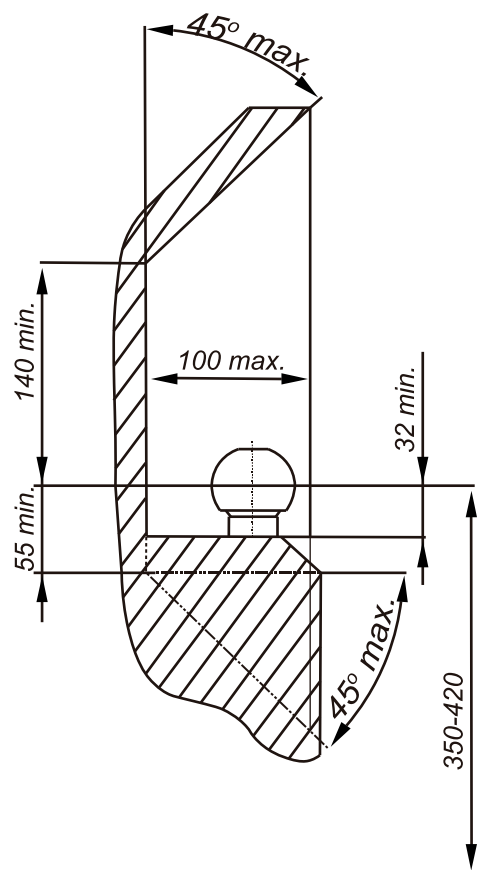

PL Należy zagwarantować przestrzeń swobodną według załącznika VII, rysunek 25a/b Regulaminu EKG ONZ 55.01 przy dopuszczalnym ciężarze całkowitym pojazdu.

F L'espace libre doit être garanti conformément à l'annexe VII, illustration de la réglementation 55.01 CE pour un poids total en charge autorisé du véhicule.







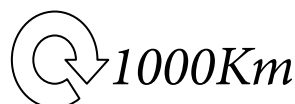

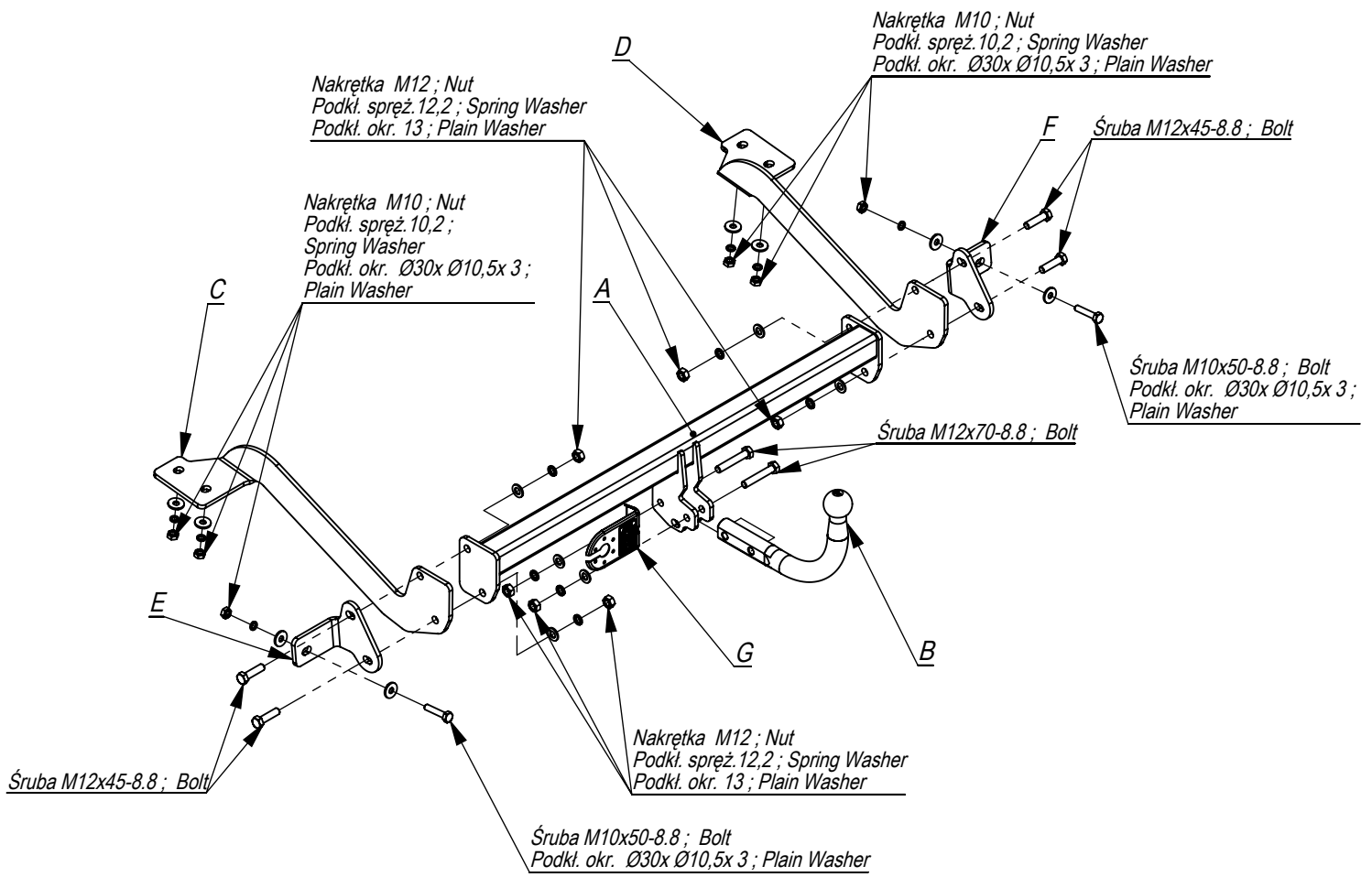

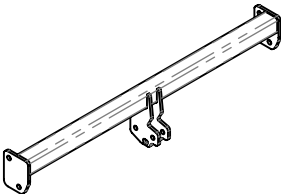
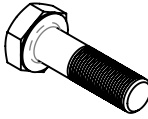
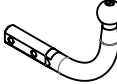
GB The clearance specified in appendix VII, diagram 25a/b of Regulation No. 55.01 UN EU must be guaranteed at laden weight of the vehicle.

D Der Freiraum nach Anhang VII, Abbildung 25a/b der Vorschriften 55.01 EG ist zu gewährleisten bei zulässigem Gesamtgewicht des Fahrzeuges.

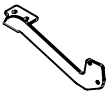
Moment skręcający dla śrub i nakrętek (8.8) Torque settings for nuts and bolts (8.8)	
M8	25Nm
M10	55Nm
M12	85Nm
M14	135Nm
M16	195Nm





	A	x1		M12x70	2
				M12x45	4
				M10x50	2
	B	x1		M12	6
				M10	6
	C	x1		Ø30xØ10,5x3	8
				13	6
	D	x1		12,2	6
				10,2	6
	E	x1			
	F	x1			
	G	x1			

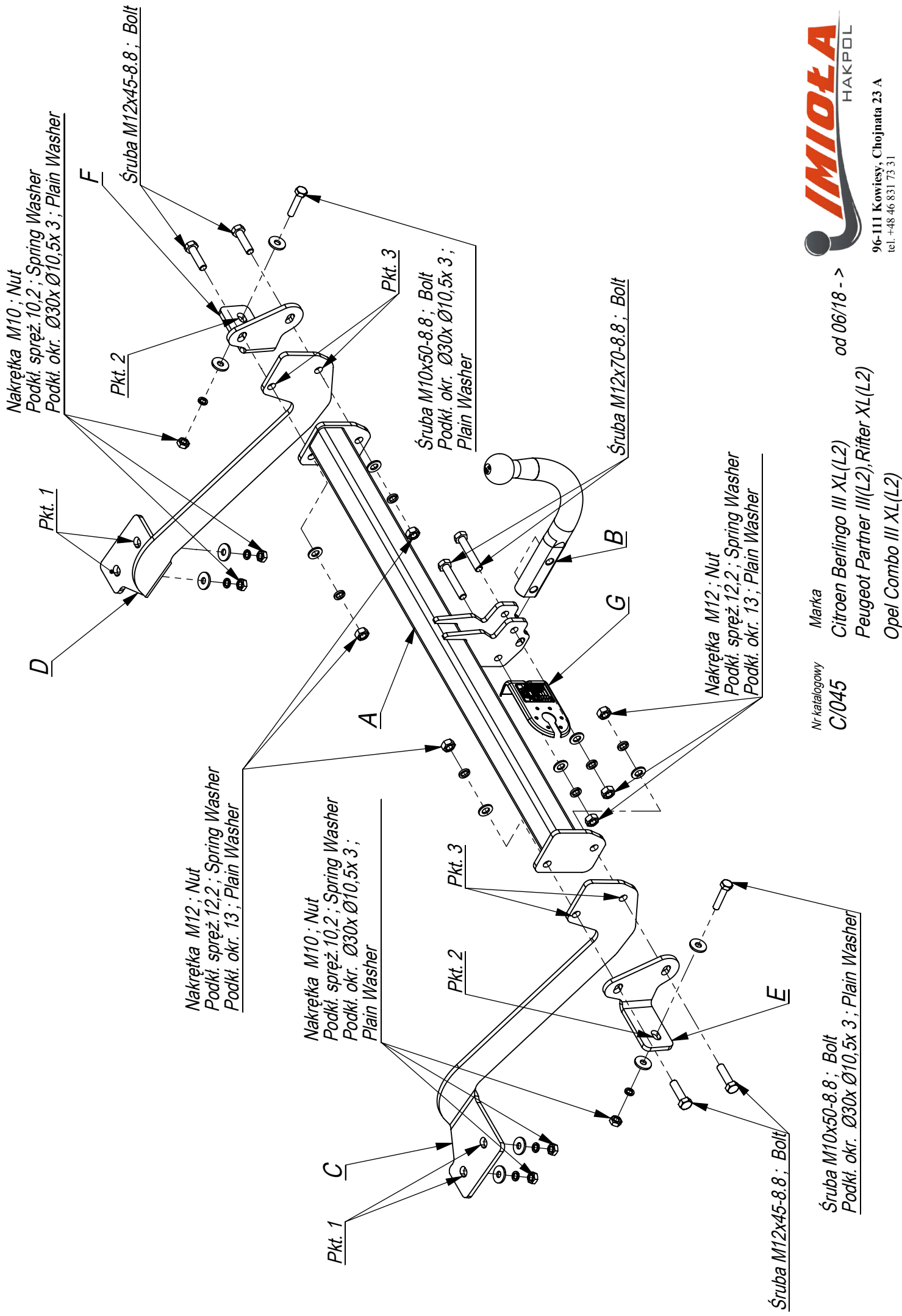

Nr katalogowy
C/045

Marka
Citroen Berlingo III XL(L2)
Peugeot Partner III(L2), Rifter XL(L2)
Opel Combo III XL(L2)

od 06/18 ->

- Odkręcić koło zapasowe.
- Nałożyć elementy C i D na wystające śruby w podłużnicach, (po uprzednim zdemontowaniu wsporników) - lekko skręcić nakrętkami M10 (pkt 1).
- Przykręcić belkę zaczepu A do elementów C i D stosując wsporniki E i F śrubami M12x45 8.8 (pkt 3) oraz śrubami M10x50 8.8 (pkt 2).
- Dokręcić śruby z momentem wg tabeli.
- Podłączyć instalację elektryczną.
- Przykręcić kulę i podstawę gniazda elektrycznego.
- Przykręcić koło zapasowe.

- Unscrew the spare wheel.
- Put the elements C and D on the protruding bolts in the metal clamps (after unscrew the supporters) – screw slightly with nuts M10 (point 1).
- Screw the main bar A to the elements C and D using supporters E and F with bolts M12x45 8.8 (point 3) and with bolts M10x50 8.8 (point 2).
- Tighten all the bolts according to the torque setting- see the table.
- Connect the electric wires.
- Fix the ball and electric plate.
- Screw the spare wheel.

- Dévisser la roue de rechange.
- Mettre les éléments C et D sur les boulons dans les longerons (après avoir démonté les supports) - serrer légèrement avec les écrous M10 (point 1).
- Serrer la poutre du crochet A aux éléments C et D en utilisant les supports E et F et les vis M12x45 8.8 (point 3) et les vis M10x50 8.8 (point 2).
- Serrer tous les boulons avec un couple de serrage selon tableau.
- Raccorder le circuit électrique.
- Visser la boule et la tôle de la prise électrique.
- Visser la roue de rechange.

- Das Ersatzrad abschrauben.
- Die Tragteile C und D auf die herausragenden in den Längsträgern Schrauben aufsetzen.
- Den Querbalken A an die Tragteile C und D mit der Anwendung von Stützen E und F mit den Schrauben M12x45 8.8 (Punkt 3) und den Schrauben M10x50 8.8 (Punkt 2) anschrauben.
- Alle Schrauben mit dem in der Tabelle angegebenen Drehmoment festziehen.
- Die Elektroinstallation anschließen.
- Die Kugel und die Steckdosenhalterung anschrauben.
- Das Ersatzrad anschrauben.

- Desenroscar la rueda de repuesto.
- Colocar los elementos C y D sobre los tornillos elevados en el chasis (después de desmontar los voladizos) - apretar suavemente con las roscas M10.
- Apretar la barra de la grapa A a los elementos C y D usando elementos E i F con tornillos M12x45 8.8 (punto 3) y con los tornillos M10x50 8.8 (punto 2).
- Apretar todos los tornillos con el par según la tabla anterior.
- Conectar la instalación eléctrica.
- Atornillar la bola y el soporte de la toma de corriente con tornillos M12x70 8.8 el uso obligatorio una arandela dentada E.
- Atornillar la rueda de repuesto.

