



# MERCEDES GLK (X204)

07/2009 - 09/2015

Cat. No. M/045

**E20**

E20\*55R01/07\*005533\*00

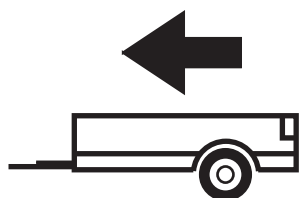

2400kg



100kg

**D = 12,01kN**

D (kN) =



MAX kg

x

MAX kg

x 0,00981



MAX kg

+

MAX kg

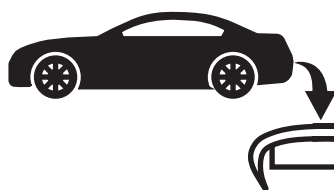

IMIOLA HAK-POL

96-111 KOWIESY, CHOJNATA 23A, POLAND

Tel. + 48 46 831 73 31, fax +48 831 74 29

e-mail: office@imiola.pl, www.imiola.pl

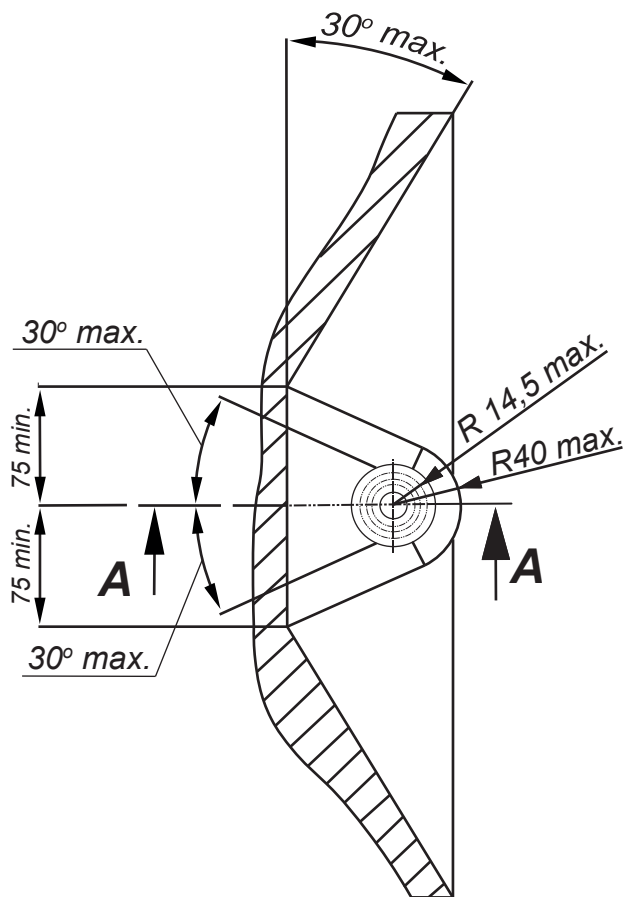

## PRZEKRÓJ A-A

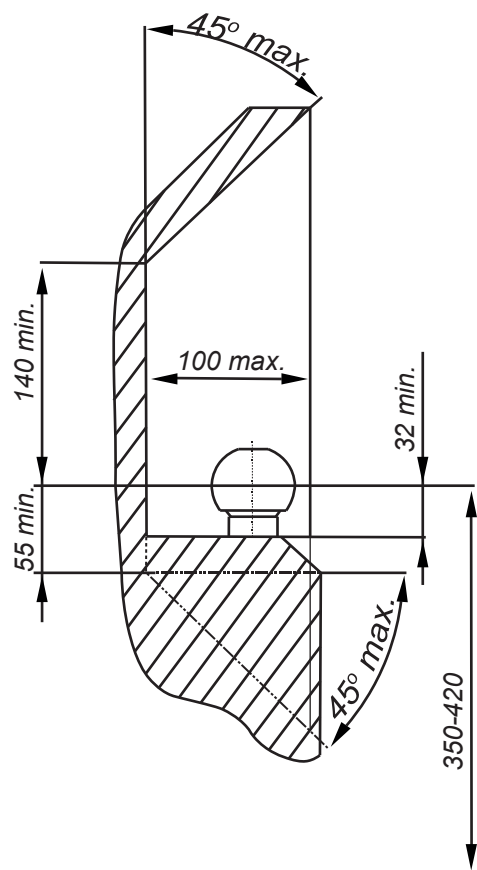

**PL** Należy zagwarantować przestrzeń swobodną według załącznika VII, rysunek 25a/b Regulaminu EKG ONZ 55.01 przy dopuszczalnym ciężarze całkowitym pojazdu.

**F** L'espace libre doit être garanti conformément à l'annexe VII, illustration de la réglementation 55.01 CE pour un poids total en charge autorisé du véhicule.

**GB** The clearance specified in appendix VII, diagram 25a/b of Regulation No. 55.01 UN EU must be guaranteed at laden weight of the vehicle.

**D** Der Freiraum nach Anhang VII, Abbildung 25a/b der Vorschriften 55.01 EG ist zu gewährleisten bei zulässigem Gesamtgewicht des Fahrzeuges.

Moment skręcający dla śrub i nakrętek (8.8) Torque settings for nuts and bolts (8.8)	
M8	25Nm
M10	55Nm
M12	85Nm
M14	135Nm
M16	195Nm

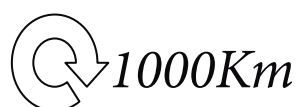

Śruba M10x40-8.8 ; Bolt  
Podkł. okr. 10,5 ; Plain Washer

Śruba M10x35-8.8 ; Bolt  
Podkł. spręż. 10,2 ; Spring Washer  
Podkł. okr. 10,5 ; Plain Washer

Nakrętka M10 ; Nut  
Podkł. spręż. 10,2 ; Spring Washer  
Podkł. okr. Ø30x Ø10,5x 3 ;  
Plain Washer







Nakrętka M12 ; Nut  
Podkł. spręż. 12,2 ; Spring Washer  
Podkł. okr. 13 ; Plain Washer

Śruba M10x40-8.8 ; Bolt  
Podkł. okr. 10,5 ; Plain Washer

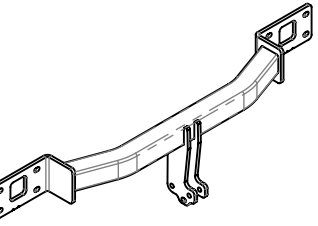
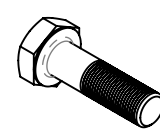
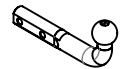
Nakrętka M10 ; Nut  
Podkł. spręż. 10,2 ; Spring Washer  
Podkł. okr. Ø30x Ø10,5x 3 ; Plain Washer

Nakrętka M10 ; Nut  
Podkł. spręż. 10,2 ; Spring Washer  
Podkł. okr. Ø30x Ø10,5x 3 ; Plain Washer

Śruba M12x70-8.8 ; Bolt

	A	x1		M12x70	2
				M10x40	8
				M10x35	4
	B	x1		M10	8
					Ø30xØ10,5x3
	C	x1		10,5	12
					E
10,2	12				

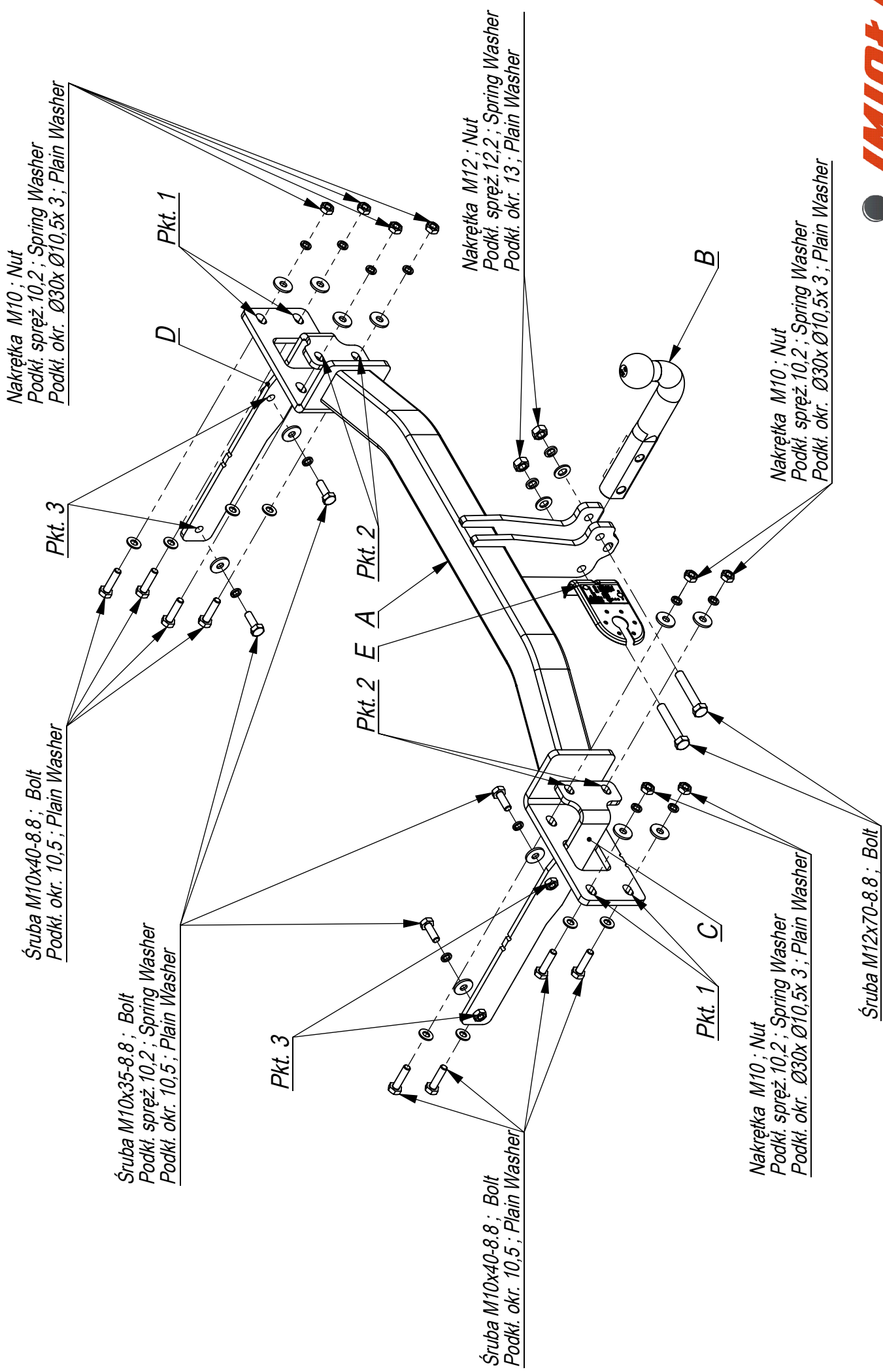

Nr katalogowy  
**M/045**

Marka  
**Mercedes GLK (X204)**

od 07/09-09/15

96-111 Kowiesy, Chojnata 23 A  
 tel. +48 46 831 73 31

- Odkręcić lampy i zderzak. Wyjąć dywanik bagażnika.
- Odkręcić belkę zderzeniową (nie będzie już wykorzystana).
- Opuścić tłumik z zawiesia.
- Belkę haka A przykręcić tylnego pasa lekko śrubami M10x40 8.8 (pkt 1).
- Elementy C i D wsunąć w podłużnice lekko przykręcając śrubami M10x35 (pkt 3).
- Następnie skręcić elementy C i D z belką haka A śrubami M10x40 8.8 (pkt 2).
- Dokręcić wszystkie śruby z momentem według tabeli.
- Przykręcić tłumik.
- Założyć zderzak i lampy.
- Dokręcić kulę i blachę gniazda elektrycznego śrubami M12x70.
- Podłączyć instalację elektryczną.

- Unscrew the lamps and bumper. Take out the carpeting from the boot.
- Unscrew the bumper bar (it will not be used any more).
- Lower the muer from the hanger.
- Screw the main bar A to the rear belt with bolts M10x40 8.8 (point 1).
- Insert the elements C and D into frame side members and screw slightly with bolts M10x35 8.8 (point 3).
- Screw the elements C and D to the main bar A with bolts M10x40 8.8 (point 2).
- Tighten all the bolts according to the torque setting- see the table.
- Screw the muer.
- Screw the bumper and lamps.
- Fix the ball and electric plate with bolts M12x70 8.8.
- Connect the electric wires.

- Dévisser le pare-chocs et les lampes. Enlever le revêtement du core.
- Dévisser la poutre pare-chocs de la voiture (elle ne sera plus utilisée).
- Enlever le pot d'échappement de la suspension.
- Visser la barre de crochet A à la jupe arrière légèrement avec les boulons M10x40 8.8 (point 1).
- Glisser les éléments C et D dans les longerons et les visser légèrement avec les boulons M10x35 (point 3).
- Ensuite serrer les éléments C et D avec la barre de crochet A avec les boulons M10x40 8.8 (point 2).
- Serrer tous les boulons avec un couple de serrage selon tableau.
- Visser le pot d'échappement.
- Installer le pare-chocs et les lampes.
- Serrer la boule et la tôle de la prise électrique avec les boulons M12x70.
- Brancher l'installation électrique.

- Die Rückleuchten und den Stoßfänger abschrauben.
- Den Stoßträger abschrauben (wird nicht mehr benötigt)..
- Den Schalldämpfer vom Halter absenken.
- Den AHK-Querträger A am hinteren Band mit Schrauben M10x40 8.8 leicht anschrauben (Punkt 1).
- Die Bauteile C und D in die Längsträger einschieben und mit Schrauben M10x35 leicht anziehen.
- Danach die Bauteile C und D mit den AHK-Querträger A mit Schrauben M10x40 8.8 (Punkt 2) zusammenschrauben.
- Ziehen Sie alle Schrauben mit dem Drehmoment gemäß der Tabelle an.
- Den Schalldämpfer anschrauben.
- Den Stoßfänger und die Rückleuchten einsetzen.
- Schrauben Sie die Kugel und den Steckdosenblech mit den Schrauben M12x70 an.
- Die elektrische Installation anschließen.

- Desensrosque las lámparas y el parachoques. Retirar la alfombra del maletero.
- Desensrosque las lámparas, baje el silenciador y desatornille el protector térmico.
- Baje el silenciador de la suspensión.
- Apretar la barra del gancho A ligeramente a la correa trasera con los tornillos M10x40 8.8 (punto 1).
- Insertar los elementos C y D en los largueros atornillando ligeramente los tornillos M10x35 (punto 3).
- A continuación, jar los elementos C y D a la barra del gancho A con los tornillos M10x40 8.8 (punto 2).
- Apretar todos los tornillos con el par según la tabla anterior.
- Fijar el silenciador.
- Montar el parachoques y las luces.
- Apretar la bola y la placa de la toma eléctrica usando tornillos M12x70.
- Conectar la instalación eléctrica.

